

As pessoas são o centro de tudo o que fazemos. Por isso, a Motiva pensou em produtos elegantes e funcionais e os desenvolveu para que promovam a qualidade de vida, o bem-estar e a motivação no ambiente de trabalho, trazendo de volta o espírito de coletividade e o calor humano aos espaços corporativos a fim de que as pessoas tenham experiências cada vez mais humanas no seu ambiente de trabalho.

*Personas son la principal razón para todo lo que hacemos. Por eso que Motiva ha pensado en productos elegantes y funcionales que buscan promover la calidad de vida, el bienestar y la motivación en el ambiente de trabajo, rescatando el principio de colectividad y calor humano en los espacios corporativos para que las personas tengan experiencias cada vez más humanas todos los días, en todos los momentos de sus vidas.*

M-corp products were planned and developed to bring humanity, well-being and motivation back to the workplace. By providing an elevated work experience to your staff, you will help them achieve their strategic goals.

■  
**BALCÃO DE  
ATENDIMENTO**  
RECEPCIÓN  
*RECEPTION DESK*





Módulos de balcão de atendimento / Módulos recepción / Reception modules:  
825357 / 825363 / 825362 / 825353 / 825361 / 825358 / 818320 / 818330  
Armários / Armarios / Cabinets: 825715



■ **Módulo 818320 diseñado para receber iluminação LED (não fornecida).**

Módulo 818320 diseñado para recibir iluminación LED (no proveído).  
*Ref. 818320 can be equipped with LED lighting (not provided).*



■ **PLATAFORMAS**

ESTACIONES LINEALES  
*BENCHING*











Plataforma dupla / Estación lineal 2 puestos / 2-people benching: **825267**  
Extensão plataforma dupla / Extensión estación lineal 2 puestos / Extension for 2-people benching: **825237**



Plataforma dupla / Estación lineal 2 puestos / 2-people benching: **825277**  
Extensão plataforma dupla / Extensión estación lineal 2 puestos / Extension for 2-people benching: **825237**





Plataforma dupla / Estación lineal 2 puestos / 2-people benching: **825475**  
Extensão plataforma dupla / Extensión estación lineal 2 puestos / Extension for 2-people benching: **825435**



**Caixa conectividade metálica  
(tomadas elétricas inclusas).**

Caja conectividad metálica.  
Metal power box.



**Painel acústico de fibra  
- usado sobre plataformas.**

Panel acústico de fibra  
- usado en estaciones lineales.  
*Acoustic divider*  
- to be used on benches.



Produto redutor de ruído.  
Producto reductor de ruido.  
*Noise reducer product.*



Produto anti-chama.  
Producto retardante de llama.  
*Flame-retardant fiber.*



■  
**MESAS**

ESCRITORIOS  
WORKDESKS

Mesa executiva / Escritorio ejecutivo / Executive desk: **825505**  
Módulos componíveis / Módulos Componibles / Modular Products





Mesa ejecutiva / Escritorio ejecutivo / Executive desk: **825507**



Mesa ejecutiva / Escritorio ejecutivo / Executive desk: **825501**



Mesa ejecutiva / Escritorio ejecutivo / Executive desk: **825501**



Mesa ejecutiva / Escritorio ejecutivo / Executive desk: **825503**



Mesa / Escritório / Workdesk: **825189**  
 Armários / Armarios / Cabinets: **825705 / 825707 / 825711 / 825719 / 825723 / 825725**  
 Gaveteiros / Cajoneros / Drawer units: **825826**  
 Divisórias / Divisorias / Dividers: **715106**



Mesa / Escritório / Workdesk: **825173**



Mesa de treinamento / Mesa de capacitación / *Everywhere table*: 825165







Mesa / Escritorio / Workdesk: **825153 / 825145**  
Armários / Armarios / Cabinets: **825727**  
Gaveteiros / Cajoneros / Drawer unit: **825817 / 825818**

■  
**MESAS DE  
REUNIÃO**

MESAS DE REUNIÓN  
*MEETING TABLES*





Mesa de reunião / Mesa de reunión / Meeting table: 825903







Mesa de reunião / Mesa de reunión / Meeting table: **825930**

■ **CALL CENTER**

CALL CENTER  
CONTACT CENTER





**Mesa com regulagem de altura.**  
Produto certificado.  
Mesa con nivelador altura.  
*Height-adjustable workdesk*





Armários / Armarios / Cabinets: **825721**  
Call center atendimento / Call center / Contact center: **825305**  
Extensão call center atendimento / Extensión del call center / Extension for contact center: **825315**

■  
**ARMÁRIOS E  
GAVETEIROS**

ARMARIOS Y  
CAJONEROS  
*ALL STORAGE*

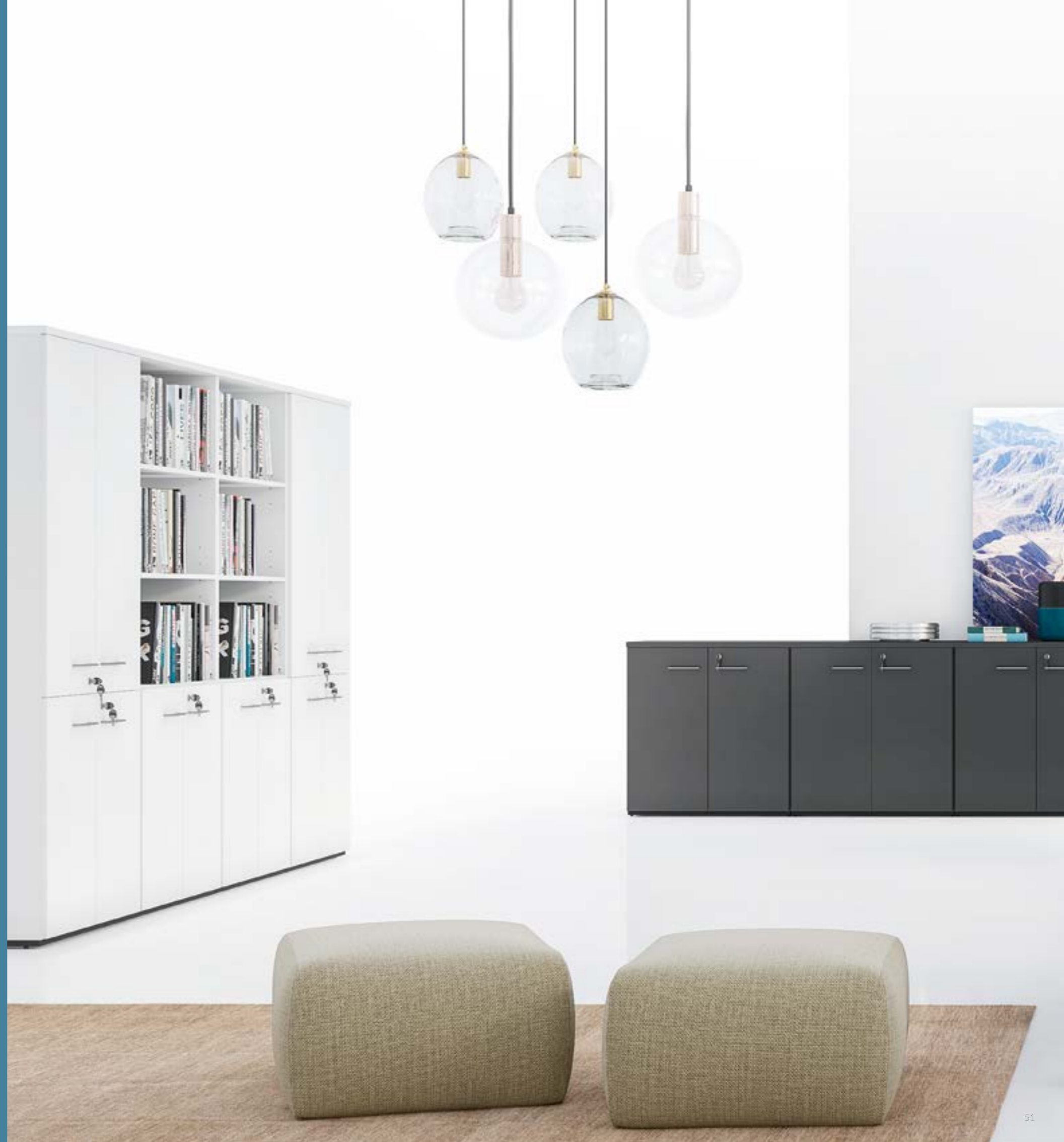



Armários / Armarios / Cabinets: **825727 / 825719 / 825705**  
Plataformas / Estación lineal / Bench: **825229 / 825239**  
Gaveteiro / Cajonero / Drawer unit: **825818**  
Armário console para plataforma com almofada / Armario / Console unit: **825742**  
Nichos / Nichos / Niches: **715172 / 715174**



# ■ MÓDULOS COMPONÍVEIS

MÓDULOS COMPONIBLES  
MODULAR PRODUCTS



















## PADRÕES

### PADRÕES FINISHES

#### Metálicos

Metálicos  
Metal Finishes

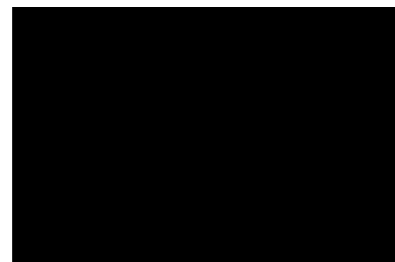

Preto / Negro / Black



Grafite / Grafito / Lead grey

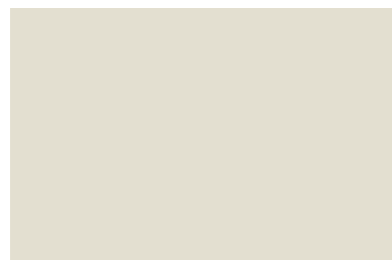

Argila / Beige / Beige

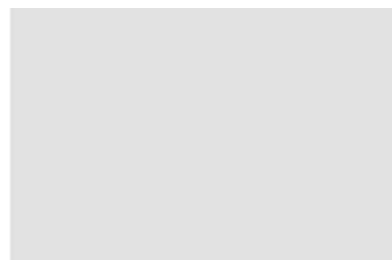

Cinza Cristal / Gris Cristal / Grey

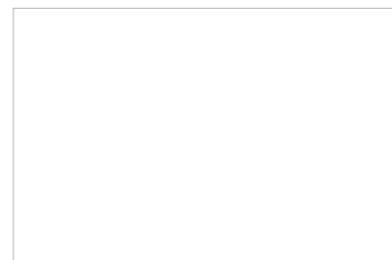

Branco / Blanco / White

#### Tecidos

Tecidos  
Textiles

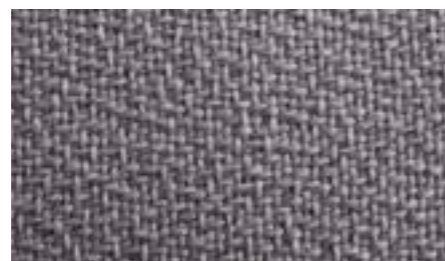

Cinza / Gris / Grey



Azul / Azul / Blue



Vermelho / Rojo / Red

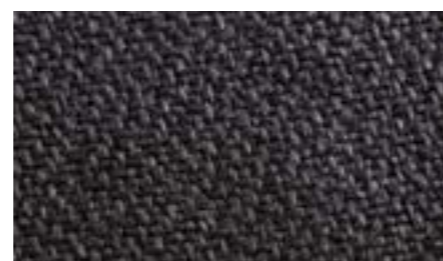

Preto / Negro / Black

#### Acabamentos MDP-BP

Acabados MDP-BP (Melamina)  
MDP-LPM (Melamine) Available Finishes



Castaine



Macadâmia

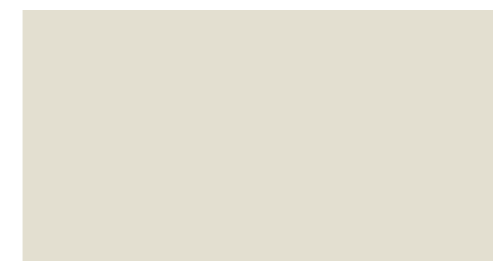

Argila / Beige / Beige



Chiaro

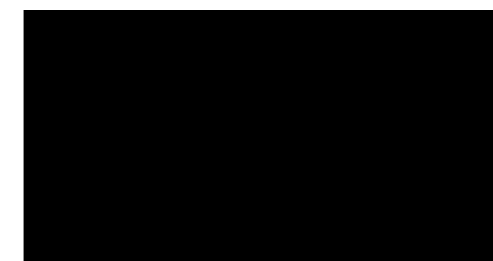

Preto / Negro / Black



Grafite / Grafito / Lead grey

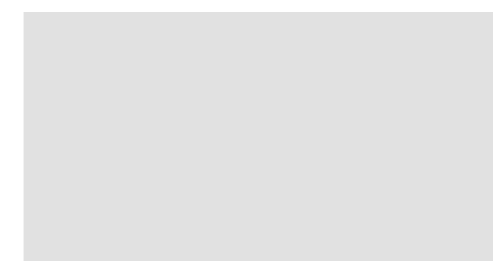

Cinza Cristal / Gris Cristal / Grey

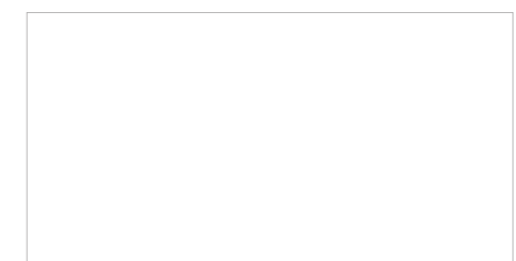

Branco / Blanco / White

## Combinação de Acabamentos MDP-BP

Combinaciones de Acabados MDP-BP (Melamina)

MDP-LPM (Melamine) Combination of Finishes

Produto Producto Product	1° Acabamento Primero acabado 1st Finish	2° Acabamento Segundo acabado 2nd Finish	3° Acabamento Tercer acabado 3rd Finish	4° Acabamento Cuarto acabado 4th Finish
Armários Armarios Cabinets	Caixa / corpo do armário Cuerpo / caja except upper top and doors	Tampo e portas Tapa y puertas Upper top and doors	-	-
Gaveteiros Cajoneros Drawer units	Caixa / corpo gaveteiro Cuerpo / caja Except upper top and drawer fronts	Tampo e frente de gavetas Tapa y frentes de cajones Upper top and drawer fronts	-	-
Mesas - pé painel Escritorio - lateral panel Workdesk	Lateral e saia Laterales y falda Side and modesty panels	Tampo Tapa Top	-	-
Mesas - pé metal Escritorio - pata metal Workdesk	Saia Falda Modesty panel	Tampo Tapa Top	Estrutura metálica Pata metálica Metal structure	-
Plataformas Estaciones lineales Benching	Tamos centrais Tapas centrales Central tops	Tamos principais Tapas principales Main tops	Estrutura metálica Estructura metálica Metal structure	Caixa de conectividade, quando houver Caja de conectividad cuando esa hace parte del diseño del producto Metal power/data box when it is part of the product.
Balcão de atendimento Mesa de recepción Reception desk	Módulo inteiro Módulo entero All ports	-	-	-
Mesa de reunião redonda - pé painel Mesa reunión redonda - base panel Rounded meeting table - wood base	Base Base Base (top support)	Tampo Tapa Top	-	-
Mesa de reunião - pé metal Mesa de reunión - pata metálica Meeting table - metal structure	Tamos principais Tapas principales Main tops	Estrutura metálica Pata metálica Metal structure	Caixa de conectividade, quando houver Caja de conectividad cuando esa hace parte del diseño del producto Metal power/data box when it is part of the product.	-

## GARANTIA MOTIVA

### Uma garantia é uma promessa.

A Garantia Motiva é a nossa promessa para você de que nós estamos atentos à qualidade dos nossos produtos. Ela reconhece a sua necessidade por móveis que permaneçam inalterados após o uso contínuo. Portanto, para ter acesso ao TERMO DE GARANTIA MOTIVA e seus detalhes, consulte a empresa.

As informações e especificações desse catálogo estão sujeitas a alterações sem aviso prévio.

Os padrões de cores aplicados aos produtos nesse material servem como referência e podem apresentar diferença de tonalidade entre as imagens e o produto real.

### Manutenção/Limpeza do Produto

MOTIVA recomenda o uso de uma flanela macia seca ou úmida em água. Quando necessário, utilize detergente com pH neutro diluído em água. Não use esponjas abrasivas uma vez que podem riscar os produtos. Evite usar ácidos, solventes e/ou qualquer outro produto que contenha amônia. A limpeza periódica aliada ao uso correto dos produtos MOTIVA, permitem que os móveis mantenham seu aspecto e performance originais por muito tempo.

### Mantenha o móvel protegido da luz solar.

### TÉRMINO DE GARANTIA

#### Una garantía es una promesa.

La Garantía Motiva es nuestra promesa para usted de que estamos atentos a la calidad de nuestros productos. Ella reconoce su necesidad por muebles que permanezcan inalterados a pesar de su uso permanente. Por eso, contáctenos para recibir el TÉRMINO DE GARANTÍA MOTIVA. Estamos a la orden.

Las informaciones y especificaciones en ese catálogo están sujetas a cambios sin previo aviso.

Los patrones de colores aplicados a los productos en ese material sirven solamente como referencia y pueden presentar diferencia de tonalidad entre las imágenes y el producto real.

### Mantenimiento/Limpieza de los Productos

MOTIVA le recomienda el uso de un paño suave seco o húmedo en agua. Cuando necesario, utilice detergente con pH neutro diluido en agua. No use esponjas abrasivas porque pueden rayar los productos. No utilice líquidos ácidos, solventes y/o cualquier otro producto que contenga amoníaco. La limpieza periódica y el uso correcto de los muebles MOTIVA permiten que el aspecto y la performance original de los productos se mantengan por mucho tiempo.

### Mantenga el mueble protegido de la luz solar.

### WARRANTY TERM

The Motiva Warranty is our promise to you that we stand behind the quality of our products. It recognizes your need for products that can stand up to continuous use. For complete term, please contact us.





The information and specifications published in this portfolio are subject to change without prior notice.

Finishes and colors are displayed for reference only and may vary by browser, monitor, or printer from the actual material color. Before specifying, refer to a physical sample for true color and detail.

### Product Care

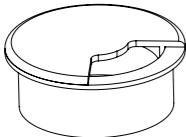
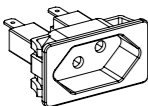
We recommend using a soft rag, either dry or wet. When needed, use pH-balanced soap diluted in water. Do not use abrasive sponges as they may leave scratches. Avoid using acidic products, solvents and products containing ammonia. Periodic and correct maintenance allows the product to keep its original aspect and lengthens the duration of its performance.

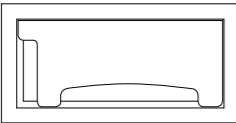
### Avoid exposure to sunlight.

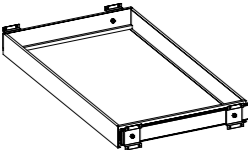
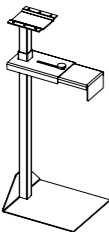

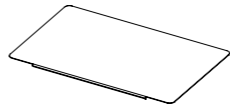
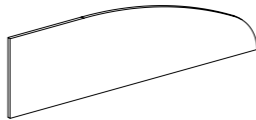
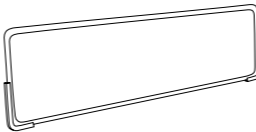
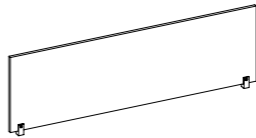
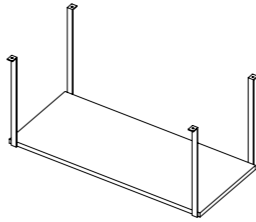
Ref.	Imagem Imagen Drawing	Descrição Descripción Basic description	Medidas   Medidas   Measurements		
			Largura (mm) Anchura (mm) Width (mm)	Altura (mm) Altura (mm) Height (mm)	Profundidade (mm) Profundidad (mm) Depth (mm)
10100		Passa cabos em pvc Pasa cables en PVC PVC cable port	60	75	25
10113		Bloco tomada 10A Ofertado solamente para Brasil For Brazilian market only	45	25	45
10125		Calha (Shaft) condutora de cabos vertical Canaleta conductora de cable vertical Vertical cable management  Usada em mesas pé painel Usada en escritorios laterales en paneles. Suitable for works desks with wood structure.	100	550	52
10126		Calha (Shaft) condutora de cabos vertical Canaleta conductora de cable vertical Vertical cable management  Usada em mesas e plataformas pé metal Usada en escritorios y estaciones con estructura metálica Suitable for works desks and benching with metal structure.	130	708	60
10129		Caixa de conectividade metálica Caja de conectividad metálica Metal power/data box ( can be use as cable port)	220	28	110
10131		Calha condutora horizontal Canaleta conductora horizontal Horizontal Cable management accessory f with power/data access.	700/60	60/80	60/60/80
10133		Informações adicionais na lista de preços. Informaciones adicionales en el listado de precios. For further information see current price list.	1100/60	60/80	60/60/80
10135			1500/60	60/80	60/60/80
10150		Suporte para pasta suspenso Soporte para carpeta colgante Support for suspended file	764	72	400
10160		Suporte metálico para CPU Soporte metálico para CPU Metal CPU support  Informações adicionais na lista de preços. Informaciones adicionales en el listado de precios. For further information see current price list.	200	570	225

Ref.	Imagem Imagen Drawing	Descrição Descripción Basic description	Medidas   Medidas   Measurements		
			Largura (mm) Anchura (mm) Width (mm)	Altura (mm) Altura (mm) Height (mm)	Profundidade (mm) Profundidad (mm) Depth (mm)
10190		Deskpad Deskpad Deskpad	1100	285	3
715102		Divisória para estação de trabalho em "L" Divisoria para estación de trabajo Delta Divider for corner desks/workstations	600	350	15
715104			1200	350	15
715106			1400	350	15
715108			1600	350	15
715110			1800	350	15
810001		Divisória acústica em fibra - usado sobre plataformas Divisoria acústica en fibra - usado en estaciones lineales Acoustic divider - to be used on benching	1100	285	3
815101		Divisória para plataforma em MDP Divisoria para estaciones lineales en MDP MDP-LPM divider for benching	800	300	18
815103			900	300	18
815105			1000	300	18
815107			1100	300	18
815109			1200	300	18
818160		Suporte para CPU suspenso Soporte para CPU sostenido Suspended CPU support	830	390	360

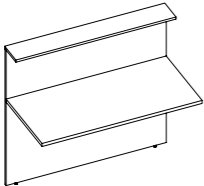
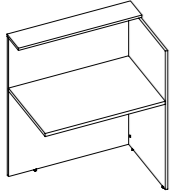
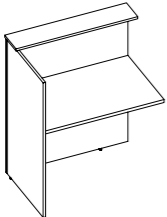
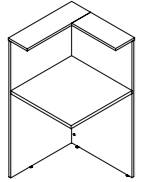
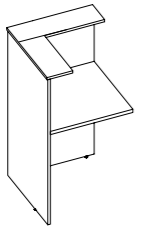
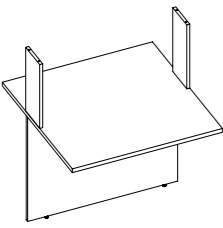
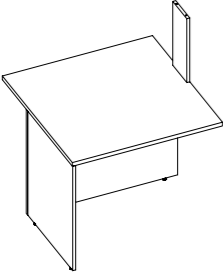
Balcão de Atendimento | Mesa de Recepção | Reception Desk

Ref.	Imagem Imagem Drawing	Descrição Descripción Basic description	Medidas   Medidas   Measurements		
			Largura (mm) Anchura (mm) Width (mm)	Altura (mm) Altura (mm) Height (mm)	Profundidade (mm) Profundidad (mm) Depth (mm)
825351		Módulo reto frontal	900	1160	600
825353		Módulo recto frontal Front module	1200	1160	600
825356		Módulo finalizador direito	900	1160	600
825358		Módulo finalizador derecho Right final module	1200	1160	600
825357		Módulo finalizador esquerdo	900	1160	600
825359		Módulo finalizador izquierdo Left final module	1200	1160	600
825361		Módulo canto direito Módulo canto derecho Right corner module	600	1160	600
825362		Módulo canto esquerdo Módulo canto izquierdo Left corner module	600	1160	600
825363		Módulo mesa central Módulo mesa central Central desk module	900	735	900
825365		Módulo mesa final esquerda Módulo mesa final izquierda Left final desk module	900	735	900

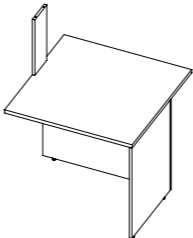
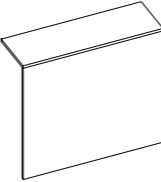
Balcão de Atendimento | Mesa de Recepção | Reception Desk

Ref.	Imagem Imagem Drawing	Descrição Descripción Basic description	Medidas   Medidas   Measurements		
			Largura (mm) Anchura (mm) Width (mm)	Altura (mm) Altura (mm) Height (mm)	Profundidade (mm) Profundidad (mm) Depth (mm)
825366		Módulo mesa final direita Módulo mesa final derecha Right final desk module	900	735	900
818320		Módulo detalhe sobreposto Módulo detalle sobrepuesto Upper detail module	900	818	300
818330		Pé de sustentação (opcional) Pata de apoyo metálica (opcional) Metal leg (optional)	40	710	40

Plataformas | Estaciones Lineales | Benching

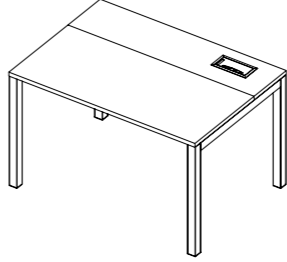
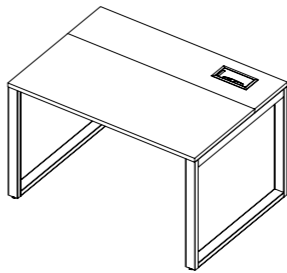
Ref.	Imagem Imagem Drawing	Descrição Descripción Basic description	Medidas   Medidas   Measurements		
			Largura (mm) Anchura (mm) Width (mm)	Altura (mm) Altura (mm) Height (mm)	Profundidade (mm) Profundidad (mm) Depth (mm)
825201		Plataforma simples - pé metal trave Estación lineal 1 puesto - pata metálica en arco 1-person benching - metal arch leg	1000	735	850
825203			1100	735	850
825205			1200	735	850
825207			1300	735	850
825209			1400	735	850
825241		Plataforma simples - pé metal quadro Estación lineal 1 puesto - pata metálica cuadrada 1-person benching - metal squared leg	1000	735	850
825243			1100	735	850
825245			1200	735	850
825247			1300	735	850
825249			1400	735	850

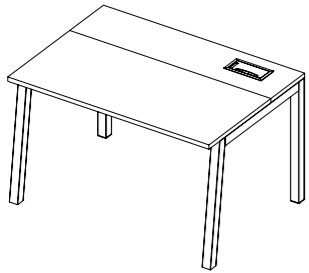
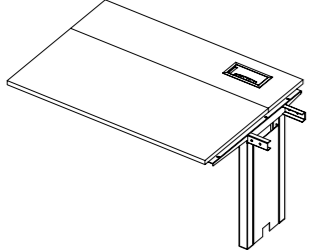
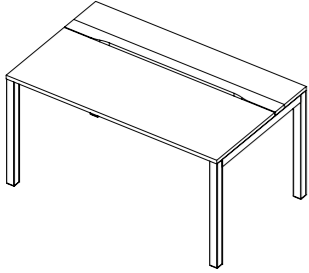
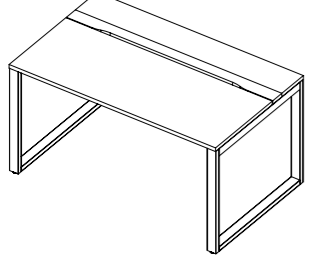
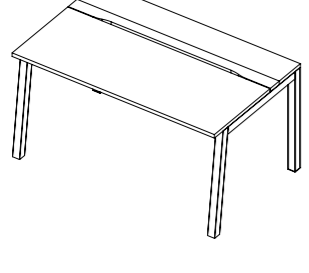

Ref.	Imagem Imagem Drawing	Descrição Descripción Basic description	Medidas   Medidas   Measurements		
			Largura (mm) Anchura (mm) Width (mm)	Altura (mm) Altura (mm) Height (mm)	Profundidade (mm) Profundidad (mm) Depth (mm)
825251		Plataforma simples - pé metal trapézio Estación lineal 1 puesto - pata metálica trapecio 1-person benching - metal trapezoidal leg	1000	735	850
825253			1100	735	850
825255			1200	735	850
825257			1300	735	850
825259			1400	735	850
825211		Extensão plataforma simples - pé metal Extensión estación lineal 1 puesto Extension for 1-person benching	1000	735	850
825213			1100	735	850
825215			1200	735	850
825217			1300	735	850
825219			1400	735	850
825401		Plataforma basculante simples - pé metal trave Estación lineal basculante 1 puesto - pata metálica en arco 1-person benching - flapping top and metal arch leg	1000	735	850
825403			1100	735	850
825405			1200	735	850
825407			1300	735	850
825409			1400	735	850
825441		Plataforma basculante simples - pé metal quadro Estación lineal basculante 1 puesto - pata metálica cuadrada 1-person benching - flapping top and metal squared leg	1000	735	850
825443			1100	735	850
825445			1200	735	850
825447			1300	735	850
825449			1400	735	850
825451		Plataforma basculante simples - pé metal trapézio Estación lineal basculante 1 puesto - pata metálica trapecio 1-person benching - flapping top and metal trapezoidal leg	1000	735	850
825453			1100	735	850
825455			1200	735	850
825457			1300	735	850
825459			1400	735	850

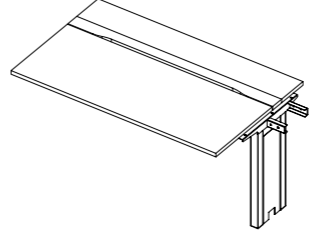
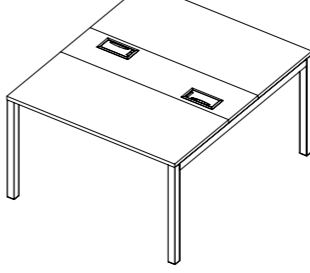
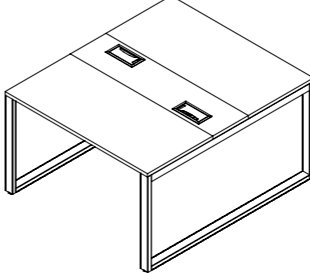
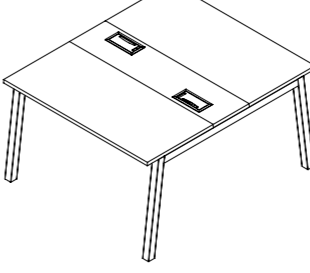
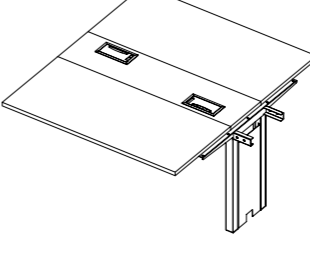
Ref.	Imagem Imagem Drawing	Descrição Descripción Basic description	Medidas   Medidas   Measurements		
			Largura (mm) Anchura (mm) Width (mm)	Altura (mm) Altura (mm) Height (mm)	Profundidade (mm) Profundidad (mm) Depth (mm)
825411		Extensão plataforma basculante simples - pé metal Extensión estación lineal basculante - 1 puesto Extension for 1-person flapping top benching	1000	735	850
825413			1100	735	850
825415			1200	735	850
825417			1300	735	850
825419			1400	735	850
825221		Plataforma dupla - pé metal trave Estación lineal 2 puestos - pata metálica en arco 2-people benching - metal arch leg	1000	735	1400
825223			1100	735	1400
825225			1200	735	1400
825227			1300	735	1400
825229			1400	735	1400
825261		Plataforma dupla - pé metal quadro Estación lineal 2 puestos - pata metálica cuadrada 2-people benching - metal squared leg	1000	735	1400
825263			1100	735	1400
825265			1200	735	1400
825267			1300	735	1400
825269			1400	735	1400
825271		Plataforma dupla - pé metal trapézio Estación lineal 2 puestos - pata metálica trapecio 2-people benching - metal trapezoidal leg	1000	735	1400
825273			1100	735	1400
825275			1200	735	1400
825277			1300	735	1400
825279			1400	735	1400
825231		Extensão plataforma dupla- pé metal Extensión estación lineal 2 puestos Extension for 2-people benching	1000	735	1400
825233			1100	735	1400
825235			1200	735	1400
825237			1300	735	1400
825239			1400	735	1400

Plataformas | Estaciones Lineales | Benching

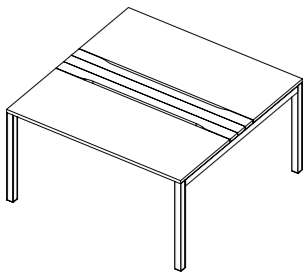
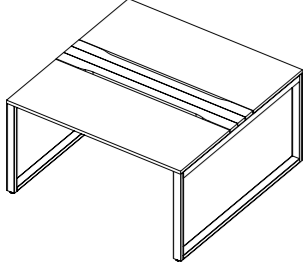
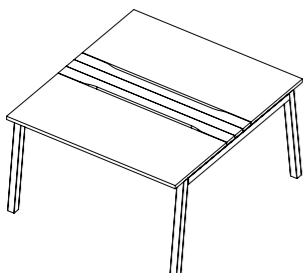
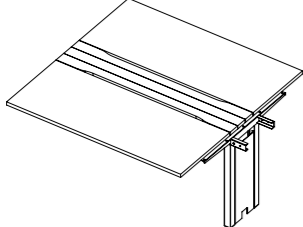
Ref.	Imagem Imagen Drawing	Descrição Descripción Basic description	Medidas   Medidas   Measurements		
			Largura (mm) Anchura (mm) Width (mm)	Altura (mm) Altura (mm) Height (mm)	Profundidade (mm) Profundidad (mm) Depth (mm)
825421		Plataforma basculante dupla - pé metal trave Estación lineal basculante 2 puestos - pata metálica en arco <i>2-people benching - flapping top and metal arch leg</i>	1000	735	1400
825423			1100	735	1400
825425			1200	735	1400
825427			1300	735	1400
825429			1400	735	1400
825461				Plataforma basculante dupla - pé metal quadro Estación lineal basculante 2 puestos - pata metálica cuadrada <i>2-people benching - flapping top and metal squared leg</i>	1000
825463	1100	735			1400
825465	1200	735			1400
825467	1300	735			1400
825469	1400	735			1400
825471		Plataforma basculante dupla - pé metal trapézio Estación lineal basculante 2 puestos - pata metálica trapecio <i>2-people benching - flapping top and metal trapezoidal leg</i>	1000	735	1400
825473			1100	735	1400
825475			1200	735	1400
825477			1300	735	1400
825479			1400	735	1400
825431		Extensão plataforma basculante dupla- pé metal Extensión estación lineal basculante 2 puestos <i>Extension for 2-people flapping top benching</i>	1000	735	1400
825433			1100	735	1400
825435			1200	735	1400
825437			1300	735	1400
825439			1400	735	1400

Mesas | Escritorios | Workdesks

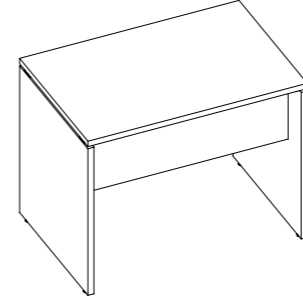
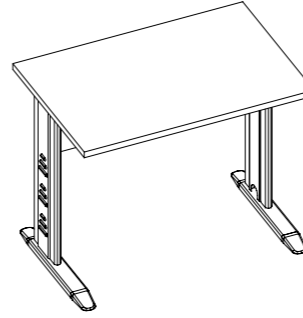
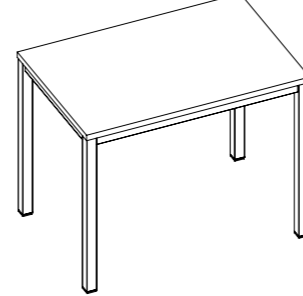
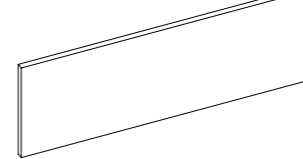
Ref.	Imagem Imagen Drawing	Descrição Descripción Basic description	Medidas   Medidas   Measurements		
			Largura (mm) Anchura (mm) Width (mm)	Altura (mm) Altura (mm) Height (mm)	Profundidade (mm) Profundidad (mm) Depth (mm)
825101		Mesa pé painel Escritorio - lateral panel <i>Workdesk</i>	900	735	600
825103			1000	735	600
825105			1200	735	600
825107			1300	735	600
825109			1500	735	600
825111			1500	735	800
825113			1800	735	800
825121				Mesa pé metal passa cabos Escritorio - lateral metal pasa cable <i>Workdesk</i>	900
825123	1000	735			600
825125	1200	735			600
825127	1300	735			600
825129	1500	735			600
825131	1500	735			800
825133	1800	735			800
825141		Mesa pé metal 40x40 Escritorio - estructura metálica tubo 40x40 <i>Workdesk - 40x40-metal structure</i>			900
825143			1000	735	600
825145			1200	735	600
825147			1300	735	600
825149			1500	735	600
825151			1500	735	800
825153			1800	735	800
818141				Saia para mesa pé metal 40x40 Falda para escritorio pata metálica 40x40 <i>Modesty panel used under 40x40-metal structure</i>	813
818143	913	430			18
818145	1113	430			18
818147	1213	430			18
818149	1413	430			18
818153	1713	430			18

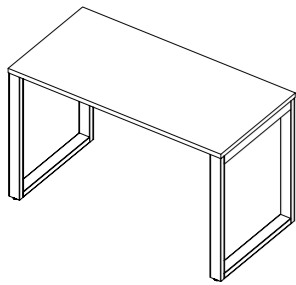
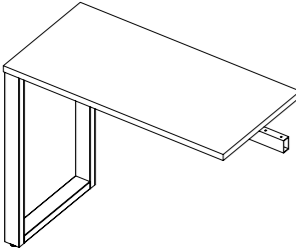
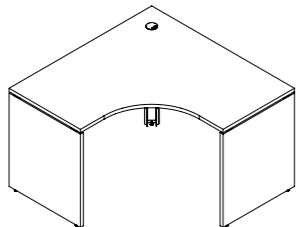
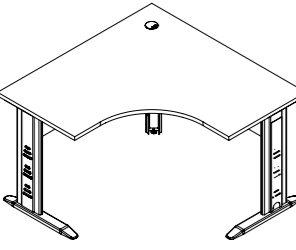
Ref.	Imagem Imagen Drawing	Descrição Descripción Basic description	Medidas   Medidas   Measurements		
			Largura (mm) Anchura (mm) Width (mm)	Altura (mm) Altura (mm) Height (mm)	Profundidade (mm) Profundidad (mm) Depth (mm)
825142		Mesa de trabalho pé quadro Escritorio - pata metálica cuadrada Workdesk - metal squared leg	900	735	600
825144			1000	735	600
825146			1200	735	600
825148			1300	735	600
825150			1500	735	600
825152			1500	735	800
825154			1800	735	800
825119				Mesa auxiliar pé metal quadro Mesa auxiliar pata metálica quadro Side console desk - metal squared leg	900
825171		Estação de trabalho - pé painel Estación de trabajo - lateral panel Corner desk	1200/1200	735	600
825173			1400/1400	735	600
825175			1600/1600	735	600
825177			1800/1800	735	600
825179			1200/1400	735	600
825181			1200/1600	735	600
825183			1400/1600	735	600
825185			1800/1200	735	600
825187				Estação de trabalho - pé metal passa cabos Estación de trabajo - pata metálica pasa cables Corner desk	1200/1200
825189	1400/1400	735			600
825191	1600/1600	735			600
825193	1800/1800	735			600
825195	1200/1400	735			600
825196	1200/1600	735			600
825197	1400/1600	735			600
825199	1800/1200	735			600

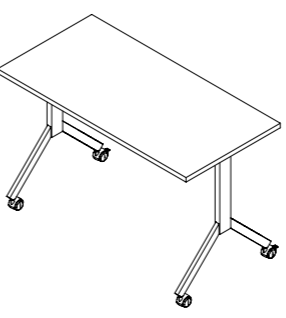
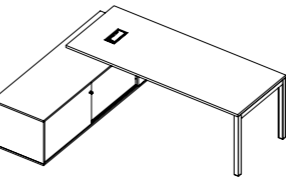
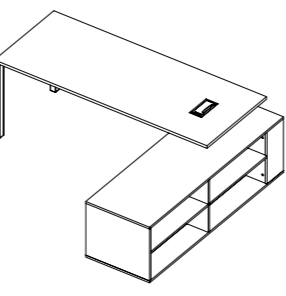
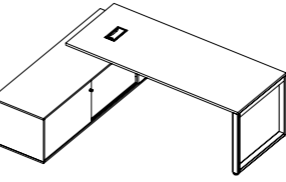
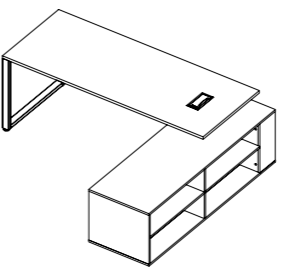
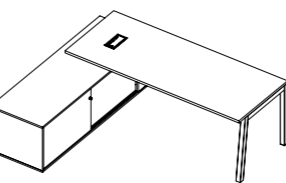
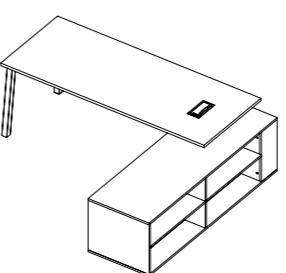
Ref.	Imagem Imagen Drawing	Descrição Descripción Basic description	Medidas   Medidas   Measurements		
			Largura (mm) Anchura (mm) Width (mm)	Altura (mm) Altura (mm) Height (mm)	Profundidade (mm) Profundidad (mm) Depth (mm)
825161		Mesa de treinamento com tampo escamoteável Mesa de capacitación con tapa rebatible Flip-top everywhere table	1000	735	600
825163			1200	735	600
825165			1350	735	600
825167			1500	735	600
825169			1600	735	600
825501				Mesa executiva esquerda - pé trave Escritorio ejecutivo izquierdo - pata metálica en arco Left executive desk - metal arch leg	2160/1800
825502		Mesa executiva direita - pé trave Escritorio ejecutivo derecho - pata metálica en arco Right executive desk - metal arch leg	2160/1800	735	800/600
825503		Mesa executiva esquerda - pé quadro Escritorio ejecutivo izquierdo - pata metálica cuadrada Left executive desk - metal squared leg	2160/1800	735	800/600
825504		Mesa executiva direita - pé quadro Escritorio ejecutivo derecho - pata metálica cuadrada Right executive desk - metal squared leg	2160/1800	735	800/600
825505		Mesa executiva esquerda - pé trapézio Escritorio ejecutivo izquierdo - pata metálica trapecio Left executive desk - metal trapezoidal leg	2160/1800	735	800/600
825506		Mesa executiva direita - pé trapézio Escritorio ejecutivo derecho - pata metálica trapecio Right executive desk - metal trapezoidal leg	2160/1800	735	800/600

Mesas | Escritorios | Workdesks

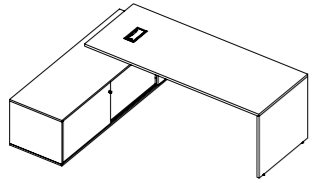
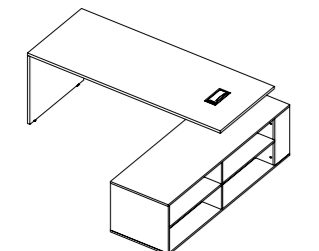
Ref.	Imagem Imagen Drawing	Descrição Descripción Basic description	Medidas   Medidas   Measurements		
			Largura (mm) Anchura (mm) Width (mm)	Altura (mm) Altura (mm) Height (mm)	Profundidade (mm) Profundidad (mm) Depth (mm)
825507		Mesa executiva esquerda - pé painel Escritorio ejecutivo izquierdo - lateral panel Left executive desk - wood structure	2160/1800	735	800/600
825508		Mesa executiva direita - pé painel Escritorio ejecutivo derecho - lateral panel Right executive desk - wood structure	2160/1800	735	800/600

Mesas de Reunião | Mesas de Reunión | Meeting Tables

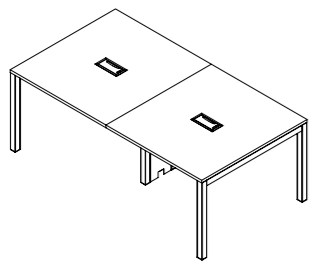
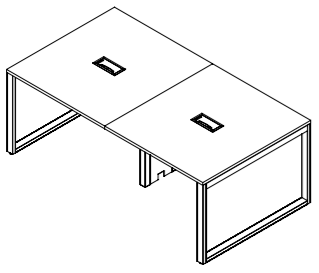
Ref.	Imagem Imagen Drawing	Descrição Descripción Basic description	Medidas   Medidas   Measurements		
			Largura (mm) Anchura (mm) Width (mm)	Altura (mm) Altura (mm) Height (mm)	Profundidade (mm) Profundidad (mm) Depth (mm)
825901		Mesa de Reunião - pé trave Mesa de reunión - pata metálica en arco Meeting table - metal arch leg	2000	735	1100
825903			2500	735	1100
825905			3150	735	1200
825907			3750	735	1200
825909			4350	735	1200
825911			5000	735	1200
825921		Mesa de Reunião - pé quadro Mesa de reunión - pata metálica cuadrada Meeting table - metal squared leg	2000	735	1100
825923			2500	735	1100
825925			3150	735	1200
825927			3750	735	1200
825929			4350	735	1200
825931			5000	735	1200

Mesas de Reunião | Mesas de Reunión | Meeting Tables

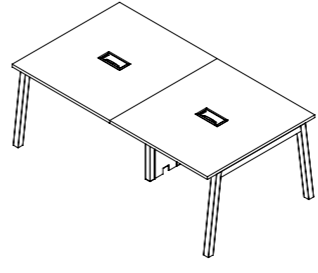
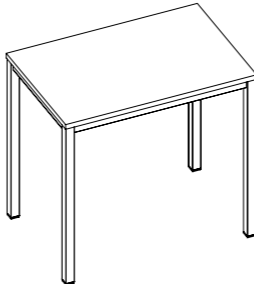
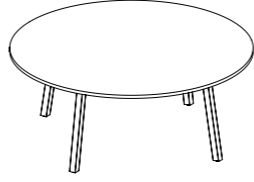
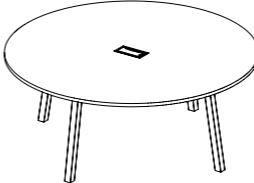
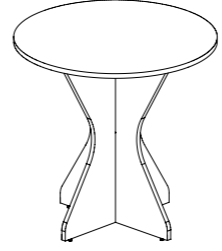
Ref.	Imagem Imagen Drawing	Descrição Descripción Basic description	Medidas   Medidas   Measurements		
			Largura (mm) Anchura (mm) Width (mm)	Altura (mm) Altura (mm) Height (mm)	Profundidade (mm) Profundidad (mm) Depth (mm)
825941		Mesa de Reunião - pé trapézio Mesa de reunión - pata metálica trapecio Meeting table - metal trapezoidal leg	2000	735	1100
825943			2500	735	1100
825945			3150	735	1200
825947			3750	735	1200
825949			4350	735	1200
825951			5000	735	1200
825920		Mesa de Reunião alta - pé metal 40x40 Mesa Reunión Alta - pata metálica 40x40 High meeting table - 40x40-metal structure	1000	1035	1000
825930		Mesa de reunião redonda Mesa de reunión redonda Rounded meeting table	1800	735	1800
825935		Mesa de reunião redonda <b>com</b> conectividade Mesa de reunión redonda <b>con</b> conectividad Rounded meeting table <b>with</b> cable management system	1800	735	1800
825950		Mesa de reunião redonda alta Mesa de reunión redonda alta High rounded meeting table	1000	1000	1000

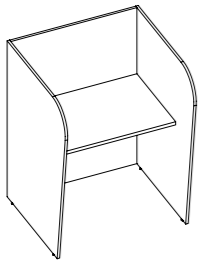
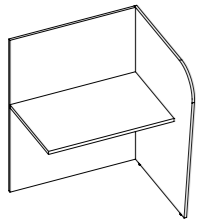
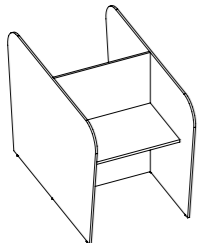
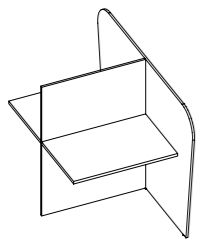
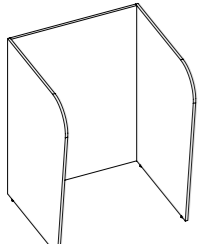
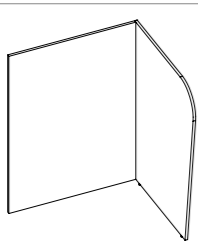
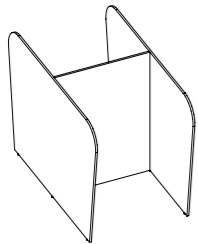
Ref.	Imagem Imagen Drawing	Descrição Descripción Basic description	Medidas   Medidas   Measurements		
			Largura (mm) Anchura (mm) Width (mm)	Altura (mm) Altura (mm) Height (mm)	Profundidade (mm) Profundidad (mm) Depth (mm)
825301		Call Center simples Call Center simples 1-person contact center desk	946	1265	900
825311		Extensão Call Center simples Extensión para Call Center simples Extension for 1-person contact center desk	928	1265	900
825302		Call Center duplo Call Center doble 2-people for contact center desk	946	1265	1800
825312		Extensão Call Center duplo Extensión para Call Center doble Extension for 2-people contact center desk	928	1265	1800
825303		Call Center simples para mesa CEM-780 Call Center simples para mesa CEM-780 1-person contact center desk for CEM-780 desk	946	1265	900
825313		Extensão Call Center simples para mesa CEM-780 Extensión para Call Center simples para mesa CEM-780 Extension for 1-person contact center desk for CEM-780 desk	928	1265	900
825304		Call Center duplo para mesa CEM-780 Call Center doble para mesa CEM-780 2-people contact center desk for CEM-780 desk	946	1265	1800

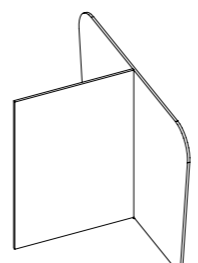
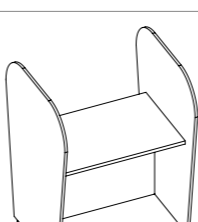
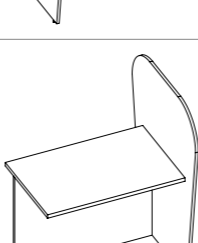
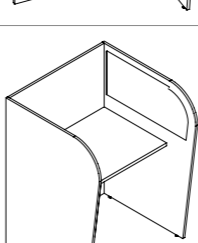
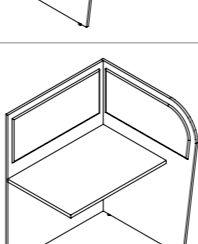
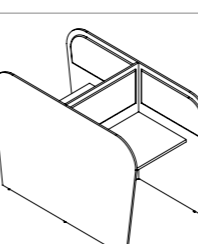
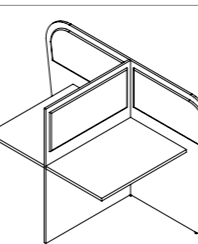
Ref.	Imagem Imagen Drawing	Descrição Descripción Basic description	Medidas   Medidas   Measurements		
			Largura (mm) Anchura (mm) Width (mm)	Altura (mm) Altura (mm) Height (mm)	Profundidade (mm) Profundidad (mm) Depth (mm)
825314		Extensão Call Center duplo para mesa CEM-780 Extensión para Call Center doble para mesa CEM-780 Extension for 2-people contact center desk for CEM-780 desk	928	1265	1800
825305		Call Center atendimento Call Center recepción Front desk contact center	946	1265	900
825315		Extensão Call Center atendimento Extensión Call Center recepción Extension fro front desk contact center	928	1265	900
825306		Call Center simples com redutor de ruído Call Center simples con reductor de ruido 1-person contact center desk with noise reducer	946	1265	900
825316		Extensão Call Center simples com redutor de ruído Extensión para Call Center simples con reductor de ruido Extension for 1-person contact center desk with noise reducer	928	1265	900
825307		Call Center duplo com redutor de ruído Call Center doble con reductor de ruido 2-people contact center desk with noise reducer	946	1265	1800
825317		Extensão Call Center duplo com redutor de ruído Extensión para Call Center doble con reductor de ruido Extension for 2-people contact center desk with noise reducer	928	1265	1800

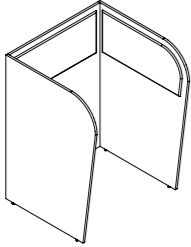
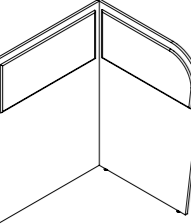
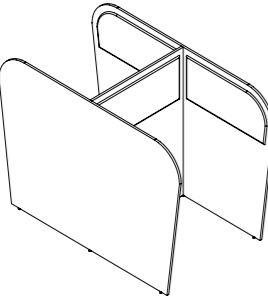
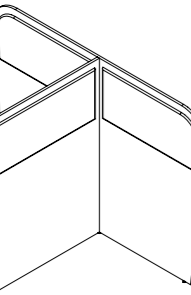
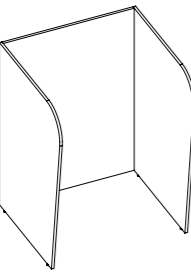
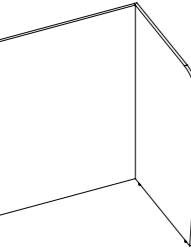

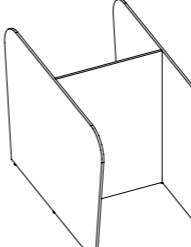
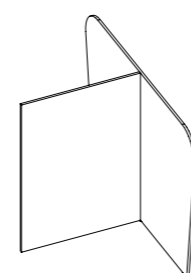
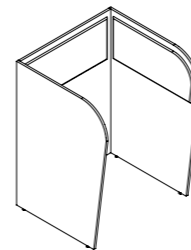
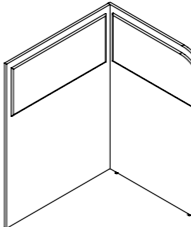
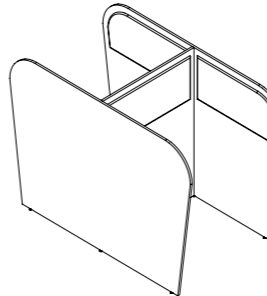
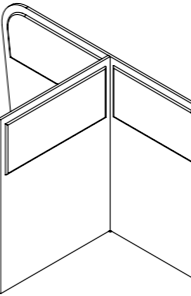

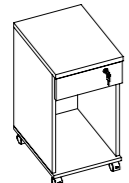
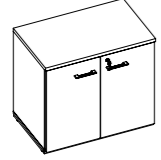
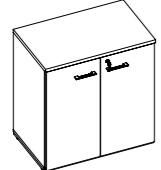
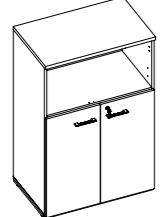
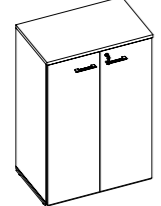
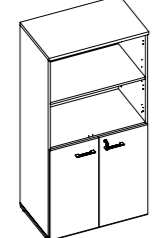
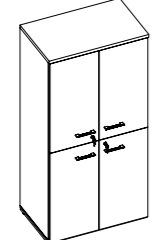

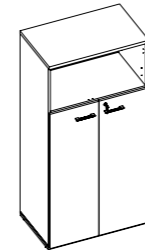
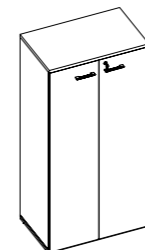
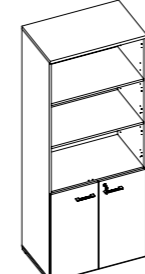
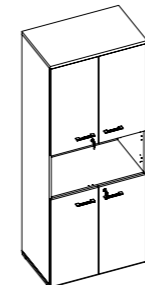
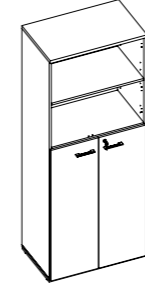
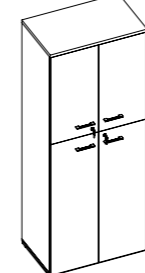
Ref.	Imagem Imagen Drawing	Descrição Descripción Basic description	Medidas   Medidas   Measurements		
			Largura (mm) Anchura (mm) Width (mm)	Altura (mm) Altura (mm) Height (mm)	Profundidade (mm) Profundidad (mm) Depth (mm)
825308		Call Center simples com redutor de ruído - para mesa CEM-780 Call Center simples con redutor de ruído - para mesa CEM-780 1-person contact center desk with noise reducer - for CEM-780 desk	946	1265	900
825318		Extensão Call Center simples com redutor de ruído - para mesa CEM-780 Extensión para Call Center simples con redutor de ruído - para mesa CEM-780 Extension for 1-person contact center desk with noise reducer - for CEM-780 desk	928	1265	900
825309		Call Center duplo com redutor de ruído - para mesa CEM-780 Call Center doble con redutor de ruído - para mesa CEM-780 2-people contact center desk with noise reducer - for CEM-780 desk	946	1265	1800
825319		Extensão Call Center duplo com redutor de ruído - para mesa CEM-780 Extensión para Call Center doble con redutor de ruído - para mesa CEM-780 Extension for 2-people contact center desk with noise reducer - for CEM-780 desk	928	1265	1800
825321		Call Center simples - para mesa CEM-782 Call Center simples - para mesa CEM-782 1-person contact center desk - for CEM-782 desk	1046	1265	912
825331		Extensão Call Center simples - para mesa CEM-782 Extensión para Call Center simples - para mesa CEM-782 Extension for 1-person contact center desk - for CEM-782 desk	1028	1265	912

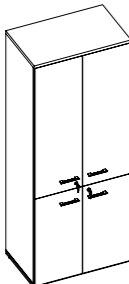
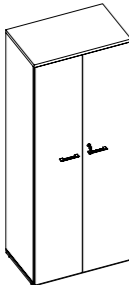
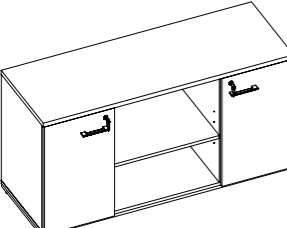
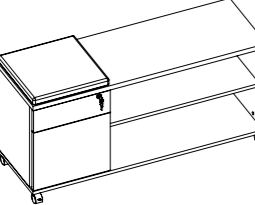
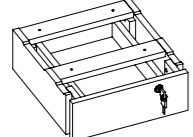
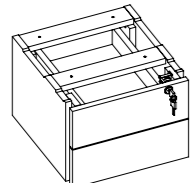
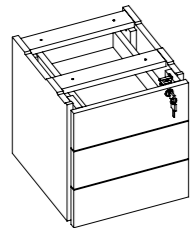
Ref.	Imagem Imagen Drawing	Descrição Descripción Basic description	Medidas   Medidas   Measurements		
			Largura (mm) Anchura (mm) Width (mm)	Altura (mm) Altura (mm) Height (mm)	Profundidade (mm) Profundidad (mm) Depth (mm)
825323		Call Center duplo - para mesa CEM-782 Call Center doble - para mesa CEM-782 2-people contact center desk - for CEM-782 desk	1046	1265	1825
825333		Extensão Call Center duplo - para mesa CEM-782 Extensión para Call Center doble - para mesa CEM-782 Extension for 2-people contact center desk - for CEM-782 desk	1028	1265	1825
825325		Call Center simples com redutor de ruído - para mesa CEM-782 Call Center simples con redutor de ruído - para mesa CEM-782 1-person contact center desk with noise reducer - for CEM-782 desk	1046	1265	912
825335		Extensão Call Center simples com redutor de ruído - para mesa CEM-782 Extensión para Call Center simples con redutor de ruído - para mesa CEM-782 Extension for 1-person contact center desk with noise reducer - for CEM-782 desk	1028	1265	912
825327		Call Center duplo com redutor de ruído - para mesa CEM-782 Call Center doble con redutor de ruído - para mesa CEM-782 2-people contact center desk with noise reducer - for CEM-782 desk	1046	1265	1825
825337		Extensão Call Center duplo com redutor de ruído - para mesa CEM-782 Extensión para Call Center doble con redutor de ruído - para mesa CEM-782 Extension for 2-people contact center desk with noise reducer - for CEM-782 desk	1028	1265	1825

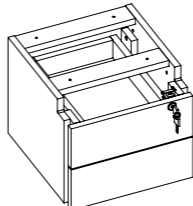
Ref.	Imagem Imagem Drawing	Descrição Descripción Basic description	Medidas   Medidas   Measurements		
			Largura (mm) Anchura (mm) Width (mm)	Altura (mm) Altura (mm) Height (mm)	Profundidade (mm) Profundidad (mm) Depth (mm)
818051		Suporte CPU com gaveta Soporte de CPU con 1 cajón 1-drawer CPU support	350	663	470
825703		Armário baixo 2 portas Armario Cabinet	800	735	500
825705		Armário dinâmico 2 portas Armario Cabinet	800	860	500
825707		Armário dinâmico 2 portas e 1 nicho Armario Cabinet	800	1260	500
825709		Armário dinâmico 2 portas Armario Cabinet	800	1260	500
825711		Armário dinâmico 2 portas e 2 nichos Armario Cabinet	800	1660	500
825713		Armário dinâmico 4 portas Armario Cabinet	800	1660	500

Ref.	Imagem Imagem Drawing	Descrição Descripción Basic description	Medidas   Medidas   Measurements		
			Largura (mm) Anchura (mm) Width (mm)	Altura (mm) Altura (mm) Height (mm)	Profundidade (mm) Profundidad (mm) Depth (mm)
825715		Armário dinâmico 2 portas e 1 nicho Armario Cabinet	800	1660	500
825717		Armário dinâmico 2 portas Armario Cabinet	800	1660	500
825719		Armário dinâmico 2 portas e 3 nichos Armario Cabinet	800	2060	500
825721		Armário dinâmico 4 portas e 1 nicho Armario Cabinet	800	2060	500
825723		Armário dinâmico 2 portas e 2 nichos Armario Cabinet	800	2060	500
825725		Armário dinâmico 4 portas Armario Cabinet	800	2060	500

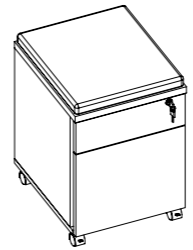
Ref.	Imagem Imagen Drawing	Descrição Descripción Basic description	Medidas   Medidas   Measurements		
			Largura (mm) Anchura (mm) Width (mm)	Altura (mm) Altura (mm) Height (mm)	Profundidade (mm) Profundidad (mm) Depth (mm)
825727		Armário dinâmico 4 portas Armario Cabinet	800	2060	500
825729		Armário dinâmico 2 portas Armario Cabinet	800	2060	500
825740		Armário final de plataforma Armario final de estación lineal 2-doors cabinet - to be used at the the end of a 2-people bench	1400	735	500
825742		Armário console para plataforma com almofada Armario consola para estación lineal con cojín Console unit with cushion - to be used under the bench	1200	610	405
825801		Gaveteiro suspenso 1 gaveta Cajonero sostenido 1 cajón 1-suspended drawer unit	350	130	378
825802		Gaveteiro suspenso 2 gavetas Cajonero sostenido 2 cajones 2-suspended drawer unit	350	260	378
825803		Gaveteiro suspenso 3 gavetas Cajonero sostenido 3 cajones 3-suspended drawer unit	350	388	391

Ref.	Imagem Imagen Drawing	Descrição Descripción Basic description	Medidas   Medidas   Measurements		
			Largura (mm) Anchura (mm) Width (mm)	Altura (mm) Altura (mm) Height (mm)	Profundidade (mm) Profundidad (mm) Depth (mm)
825804		Gaveteiro suspenso 2 gavetas Cajonero sostenido 2 cajones 2-suspended drawer unit  Utilizado somente nas mesas pé metal 40x40 Usado solamente en escritorios pata metálica 40x40 To be used at 40x40 metal structured workdesks only	350	300	378
825813		Gaveteiro volante 2 gavetas / 1 gavetão Cajonero rodante Drawer unit on casters	400	658	470
825814		Gaveteiro volante 4 gavetas Cajonero rodante Drawer unit on casters	400	658	470
825815		Gaveteiro volante compartilhado Cajonero rodante Drawer unit on casters	400	658	470
825817		Gaveteiro volante 1 gaveta e 1 gavetão com almofada Cajonero rodante Drawer unit on casters	400	590	470
825818		Gaveteiro volante 3 gavetas com almofada Cajonero rodante Drawer unit on casters	400	590	470



Armários e Gaveteiros | Armarios y Cajoneros | All Storage

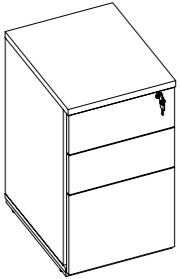
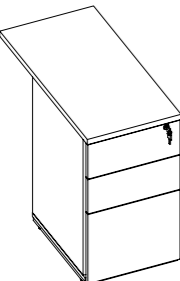

Ref.	Imagem Imagen Drawing	Descrição Descripción Basic description	Medidas   Medidas   Measurements		
			Largura (mm) Anchura (mm) Width (mm)	Altura (mm) Altura (mm) Height (mm)	Profundidade (mm) Profundidad (mm) Depth (mm)
825825		Gaveteiro fixo 2 gavetas e 1 gavetão Cajonero fijo Drawer unit	400	735	500
825826		Gaveteiro fixo 2 gavetas e 1 gavetão Cajonero fijo Drawer unit	400	735	500/600
825827			400	735	500/700
825828			400	735	500/800
825829			400	735	500/850

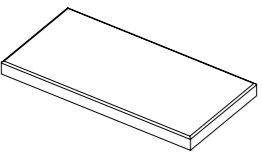
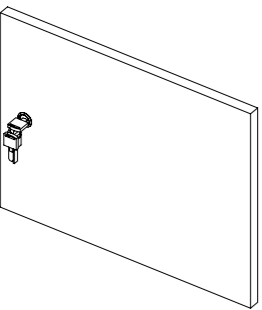
Módulos Componíveis | Módulos Componibles | Modular Products

Ref.	Imagem Imagen Drawing	Descrição Descripción Basic description	Medidas   Medidas   Measurements		
			Largura (mm) Anchura (mm) Width (mm)	Altura (mm) Altura (mm) Height (mm)	Profundidade (mm) Profundidad (mm) Depth (mm)
810101		Assento estofado Cojín tapizado Cushion top	900	450	60
818150		Porta para locker Puerta para locker Locker's door	440	343	18

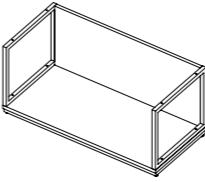
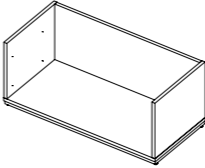
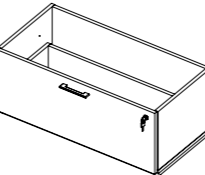
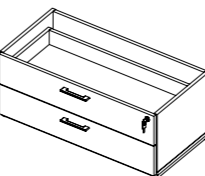
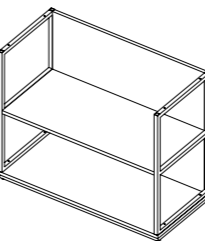
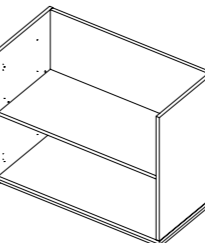
Módulos Componíveis | Módulos Componibles | Modular Products

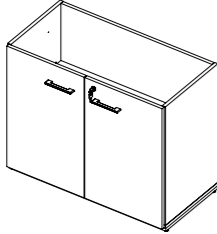
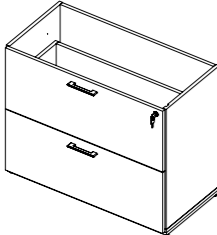
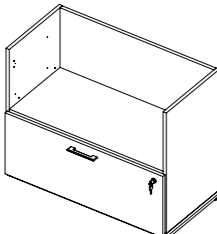
Ref.	Imagem Imagen Drawing	Descrição Descripción Basic description	Medidas   Medidas   Measurements		
			Largura (mm) Anchura (mm) Width (mm)	Altura (mm) Altura (mm) Height (mm)	Profundidade (mm) Profundidad (mm) Depth (mm)
825601		Módulo 1 nicho - lateral metal Módulo 1 nicho - lateral metal 1-niche module - metal structured sides	900	379	450
825602		Módulo 1 nicho - lateral painel Módulo 1 nicho - lateral painel 1-niche module - wood structured sides	900	379	450
825603		Módulo super baixo 1 gavetão Módulo super bajo 1 cajón 1-drawer module	900	379	450
825604		Módulo super baixo 2 gavetas Módulo super bajo 2 cajones 2-drawer module	900	379	450
825611		Módulo estante 1 prateleira - lateral metal Módulo estantería 1 repisa - lateral metal 1-shelf bookcase module - metal structured sides	900	725	450
825612		Módulo estante 1 prateleira - lateral painel Módulo estantería 1 repisa - lateral painel 1-shelf bookcase module - wood structured sides	900	725	450

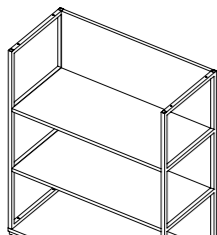
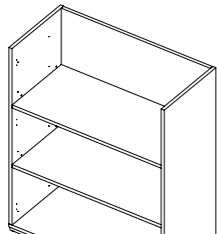
Ref.	Imagem Imagen Drawing	Descrição Descripción Basic description	Medidas   Medidas   Measurements		
			Largura (mm) Anchura (mm) Width (mm)	Altura (mm) Altura (mm) Height (mm)	Profundidade (mm) Profundidad (mm) Depth (mm)
825613		Módulo armário baixo 2 portas Módulo armario bajo 2 puertas 2-doors cabinet module	900	725	450
825614		Módulo baixo 2 gavetões Módulo bajo 2 cajones 2-drawer module	900	725	450
825615		Módulo baixo 1 gavetão / 1 nicho Módulo bajo 1 cajón / 1 nicho 1-drawer / 1-niche module	900	725	450
825616		Módulo baixo 2 gavetas / 1 gavetão Módulo bajo 2 cajones / 1 cajón grande 3-drawer module	900	725	450
825621		Módulo estante 2 prateleiras - lateral metal Módulo estantería 2 repisas - lateral metal 2-shelf bookcase module - metal structured sides	900	1071	450
825622		Módulo estante 2 prateleiras - lateral panel Módulo estantería 2 repisas - lateral panel 2-shelf bookcase module - wood structured sides	900	1071	450

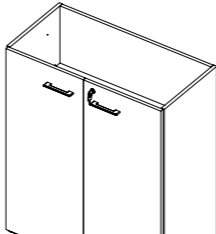
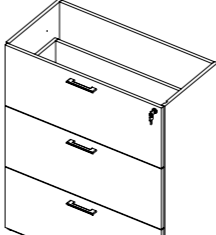
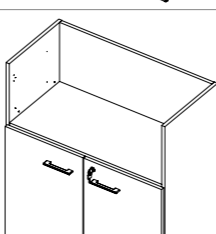
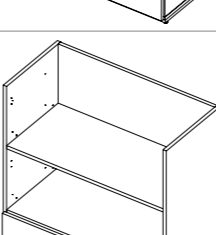
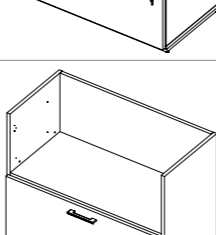
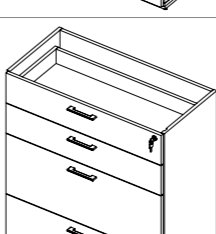

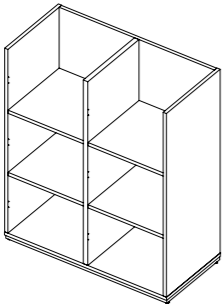
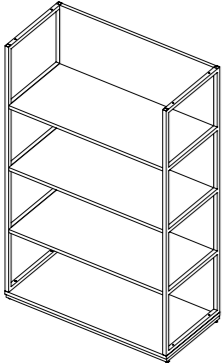
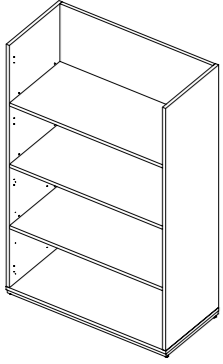
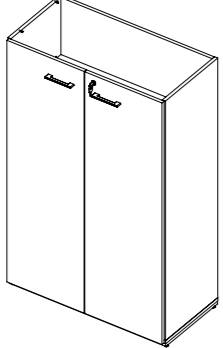
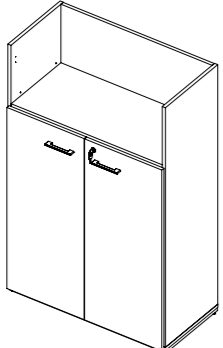
Ref.	Imagem Imagen Drawing	Descrição Descripción Basic description	Medidas   Medidas   Measurements		
			Largura (mm) Anchura (mm) Width (mm)	Altura (mm) Altura (mm) Height (mm)	Profundidade (mm) Profundidad (mm) Depth (mm)
825623		Módulo armário médio 2 portas Módulo armario mediano 2 puertas 2-door cabinet module	900	1071	450
825624		Módulo médio 3 gavetões Módulo mediano 3 cajones 3-drawer module	900	1071	450
825625		Módulo armário médio 2 portas / 1 nicho Módulo armario mediano 2 puertas / 1 nicho 2-door / 1-niche cabinet module	900	1071	450
825626		Módulo médio 1 gavetão / 2 nichos Módulo mediano 1 cajón / 2 nichos 1-drawer / 2-niches module	900	1071	450
825627		Módulo médio 2 gavetões / 1 nicho Módulo mediano 2 cajones / 1 nicho 2-drawer / 1-niche module	900	1071	450
825628		Módulo médio 2 gavetas / 2 gavetões Módulo mediano 2 cajones / 2 cajones grandes 4-drawer module	900	1071	450

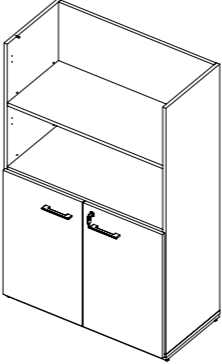
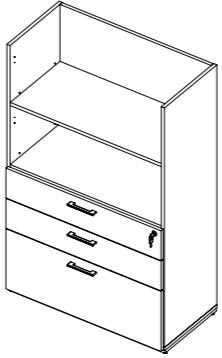
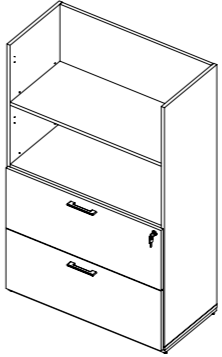
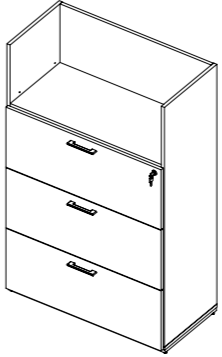
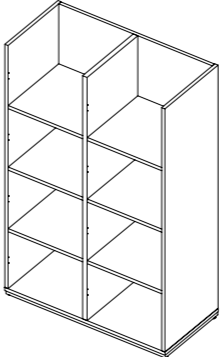
Ref.	Imagem Imagem Drawing	Descrição Descripción Basic description	Medidas   Medidas   Measurements		
			Largura (mm) Anchura (mm) Width (mm)	Altura (mm) Altura (mm) Height (mm)	Profundidade (mm) Profundidad (mm) Depth (mm)
825629		Módulo locker médio para 6 portas Módulo locker mediano para 6 puertas <i>Locker for 6 doors module</i>	900	1071	450
825631		Módulo estante 3 prateleiras - lateral metal Módulo estantería 3 repisas - lateral metal <i>3-shelf bookcase module - metal structured sides</i>	900	1416	450
825632		Módulo estante 3 prateleiras - lateral painel Módulo estantería 3 repisas - lateral panel <i>3-shelf bookcase module - wood structured sides</i>	900	1416	450
825633		Módulo armário semi alto 2 portas Módulo semialto 2 puertas <i>2-door cabinet module</i>	900	1416	450
825634		Módulo armário semi alto 2 portas / 1 nicho Módulo semialto 2 puertas / 1 nicho <i>2-door / 1-niche cabinet module</i>	900	1416	450

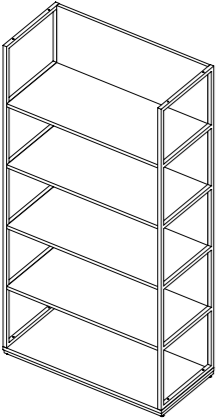
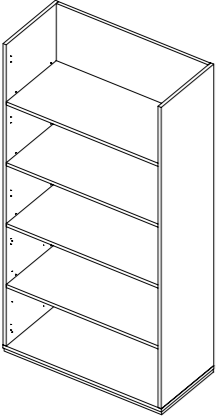
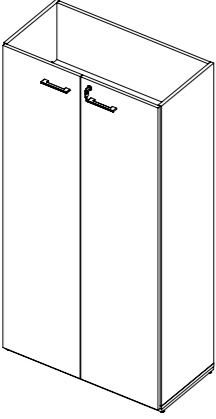
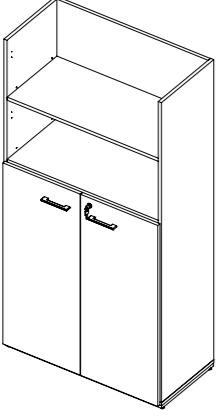
Ref.	Imagem Imagem Drawing	Descrição Descripción Basic description	Medidas   Medidas   Measurements		
			Largura (mm) Anchura (mm) Width (mm)	Altura (mm) Altura (mm) Height (mm)	Profundidade (mm) Profundidad (mm) Depth (mm)
825635		Módulo armário semi alto 2 portas / 2 nichos Módulo armario semialto 2 puertas / 2 nichos <i>2-door / 2 niches cabinet module</i>	900	1416	450
825636		Módulo semi alto 3 gavetas / 2 nichos Módulo semialto 3 cajones / 2 nichos <i>3-drawer / 2 niches module</i>	900	1416	450
825637		Módulo semi alto 2 gavetões / 2 nichos Módulo semialto 2 cajones / 2 nichos <i>2-drawer / 2 niches module</i>	900	1416	450
825638		Módulo semi alto 3 gavetões / 1 nicho Módulo semialto 3 cajones / 1 nicho <i>3-drawer / 1-niche module</i>	900	1416	450
825639		Módulo locker semi alto para 8 portas Módulo locker semialto para 8 puertas <i>Locker for 8 doors module</i>	900	1416	450

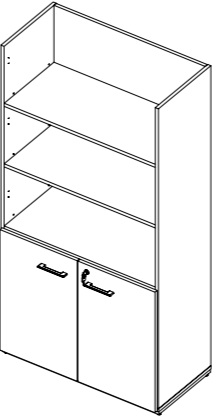
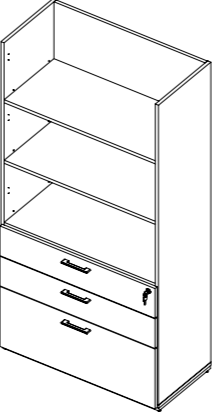
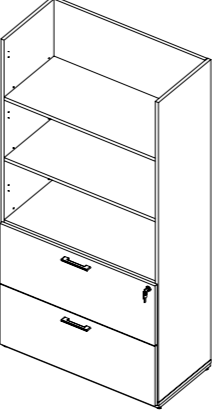
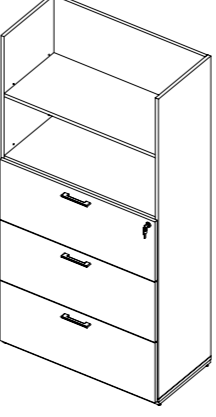
Ref.	Imagem Imagem Drawing	Descrição Descripción Basic description	Medidas   Medidas   Measurements		
			Largura (mm) Anchura (mm) Width (mm)	Altura (mm) Altura (mm) Height (mm)	Profundidade (mm) Profundidad (mm) Depth (mm)
825641		Módulo estante 4 prateleiras - lateral metal Módulo estantería 4 repisas - lateral metal 4-shelf bookcase module - metal structured sides	900	1761	450
825642		Módulo estante 4 prateleiras - lateral painel Módulo estantería 4 repisas - lateral panel 4-shelf bookcase module - wood structured sides	900	1761	450
825643		Módulo armário alto 2 portas Módulo armario alto 2 puertas 2-door cabinet module	900	1761	450
825644		Módulo armário alto 2 portas / 2 nichos Módulo armario alto 2 puertas / 2 nichos 2-door/ 2-niches cabinet module	900	1761	450

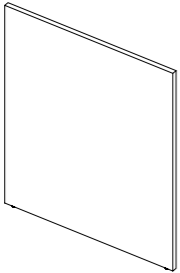
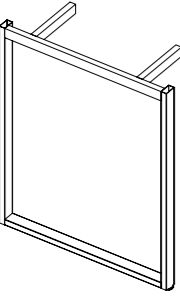
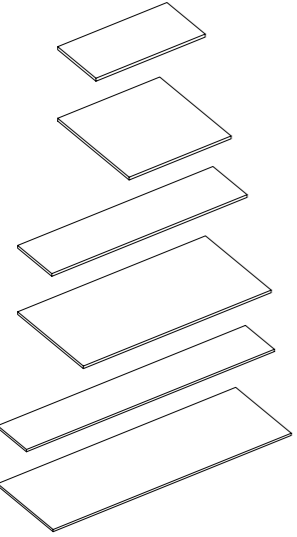
Ref.	Imagem Imagem Drawing	Descrição Descripción Basic description	Medidas   Medidas   Measurements		
			Largura (mm) Anchura (mm) Width (mm)	Altura (mm) Altura (mm) Height (mm)	Profundidade (mm) Profundidad (mm) Depth (mm)
825645		Módulo armário alto 2 portas / 3 nichos Módulo armario alto 2 puertas / 3 nichos 2-door/ 3-niches cabinet module	900	1761	450
825646		Módulo alto 3 gavetas / 3 nichos Módulo alto 3 cajones / 3 nichos 3-drawer / 3-niches module	900	1761	450
825647		Módulo alto 2 gavetões / 3 nichos Módulo alto 2 cajones grandes / 3 nichos 2-drawer / 3-niches module	900	1761	450
825648		Módulo alto 3 gavetões / 2 nichos Módulo alto 3 cajones grandes / 2 nichos 3-drawer / 2-niches module	900	1761	450

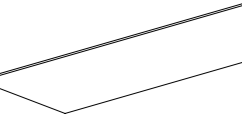
Ref.	Imagem Imagen Drawing	Descrição Descripción Basic description	Medidas   Medidas   Measurements		
			Largura (mm) Anchura (mm) Width (mm)	Altura (mm) Altura (mm) Height (mm)	Profundidade (mm) Profundidad (mm) Depth (mm)
825671		Módulo pé painel Módulo pata panel Wood workdesk side	450	725	25
825672			450	1071	25
825673			900	725	25
825674			900	1071	25
825676		Módulo pé metal Módulo pata metal Metal workdesk structure	450	725	30/60
825677			450	1071	30/60
825678			900	725	30/60
825679			900	1071	30/60
825682		Tamos Tapas Tops/surfaces	900	450	25
825683			900	900	25
825685			1800	450	25
825686			1800	900	25
825688			2700	450	25
825689			2700	900	25
810686		Barra antiempenamento Barra antipandeo Non-warping beam	800	58	30
810689			1200	58	30
818161		Saia para tampo composito mesa/ bancada (para vão de 900mm) Falda para tapa componiedo mesa (para vanos de 900mm) Modesty panel used under the tops designed as workdesk (for 900mm-span)	850	300	18

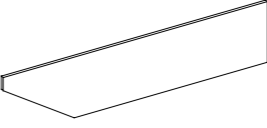
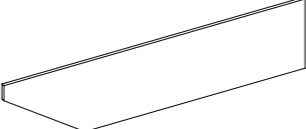
Ref.	Imagem Imagen Drawing	Descrição Descripción Basic description	Medidas   Medidas   Measurements		
			Largura (mm) Anchura (mm) Width (mm)	Altura (mm) Altura (mm) Height (mm)	Profundidade (mm) Profundidad (mm) Depth (mm)
818163		Saia para tampo composito mesa/ bancada (para vão de 1350mm) Falda para tapa componiedo mesa (para vanos de 1350mm) Modesty panel used under the tops designed as workdesk (for 1350mm-span)	1300	300	18
818167		Saia para tampo composito mesa/ bancada (para vão de 1800mm) Falda para tapa componiedo mesa (para vanos de 1800mm) Modesty panel used under the tops designed as workdesk (for 1800mm-span)	1750	300	18



Empresa familiar com mais de 30 anos que se dedica à fabricação de móveis para escritórios executivos, corporativos e móveis escolares. Situada em Bento Gonçalves - RS - região de cultura italiana e principal polo moveleiro do Brasil, trabalha baseada na honestidade e na ética para que seus produtos sejam referência de qualidade, funcionalidade, estilo singular e, que com design de vanguarda aliado à preocupação com o conforto de cada cliente, estejam presentes em todo o território nacional e em vários países do mundo.

Empresa familiar con más de 30 años de actividad que se dedica a la fabricación de muebles para oficinas ejecutivas, corporativos y muebles escolares. Ubicada en Bento Gonçalves - RS - región de cultura italiana y principal polo mobiliario de Brasil, su trabajo está basado en la honestidad y en la ética para hacer que sus productos sean referencia de calidad, funcionalidad, estilo singular y, que con diseño de vanguardia unido a la preocupación con el confort y a la comodidad del usuario, estén presentes en todo el territorio nacional y en varios países del mundo.

*A 33-year-old family business dedicated to the manufacture of furniture for executive and corporate offices and school furniture. Located in Bento Gonçalves - RS - an area with Italian culture, home to the major furniture manufacturing center in Brazil, Motiva's work is based on honesty and ethics resulting in products that are a benchmark for quality, functionality, unique style and, with avant-garde design allied to our commitment to Motiva's customer comfort, they are available throughout Brazil and in various other countries.*



Rua Giacomo Baccin, 861 // Bairro Aparecida // Caixa Postal 115 // CEP 95708-770 // Bento Gonçalves // RS // Brasil

Fone +55 54 2105.2800 // [www.motivamoveis.com.br](http://www.motivamoveis.com.br)

 /motivamoveis

 @motivamoveis